

14mm AIRGAP

Ø 6.2mm
DRILLED FOR M6 BOLTS

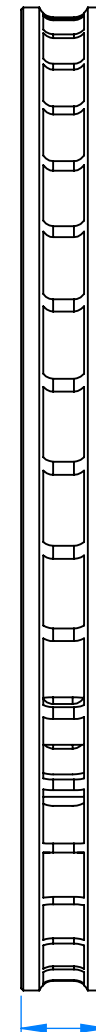

28.0

UNLESS OTHERWISE SPECIFIED:
DIMENSIONS ARE IN MILLIMETERS
SURFACE FINISH:
TOLERANCES:
LINEAR:
ANGULAR:

DEBURR AND
BREAK SHARP
EDGES

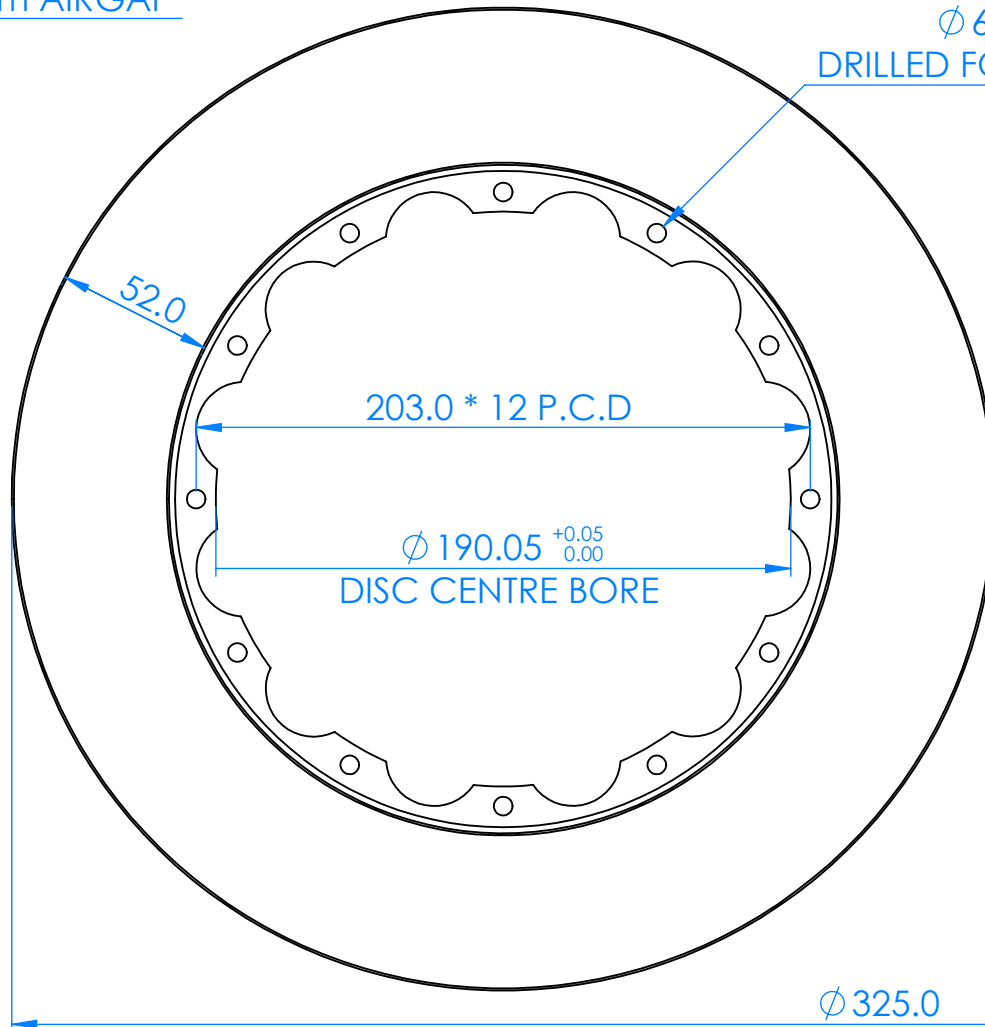

Hi SPEC
BRAKES LJK

325 * 28 ROTOR

203.0 * 12 PCD

14mm AIR GAP

52mm PAD FACE

MATERIAL: Gray Cast Iron (SN)

WEIGHT: 5597.78

DRAWN BY: Nick Bedding

DATE: 12/09/2023



SCALE: 1:2.5
DO NOT SCALE DRAWING
SHEET 1 OF 1



A4